

The Adams Motor

Magnetic energy or magnetism is the force exerted between the two magnetic poles, producing magnetization. A magnetic field is an area around the magnet where magnetic or electrical force can be experienced and is a vector quantity which has both direction and magnitude.

Any object that can produce its own magnetic field is a magnet and the direction of magnetic field is the alignment of iron filings placed on a paper over a bar magnet. These imaginary lines are useful mathematical calculations and studies. Electrical currents also produce magnetic fields likewise magnetic fields also exert forces on moving electrical charges.

In fact electricity and magnetism are the same and are related by the two phenomena are related by Maxwell's equations. Whereas electromagnetic energy will have both electrical and magnetic components and X rays, infrared rays, visible light and radio waves are all examples of electromagnetic radiation. Though these are basically electromagnetic rays their wavelengths and frequencies are different and hence behave differently. X rays are high frequency and short wavelength rays whereas microwave has longer wavelength and low frequencies.

Magnetic energy is a good source of renewable energy, which can be recycled to meet the energy needs of the world without causing pollution and it can also be used for even household energy requirements and then recycle the energy back into the environment without producing pollution. The reputed car maker, "Peugeot" has made use of the same polarity magnetic field application in designing its car, "Magnet". Magnetic energy is a great source of energy and a pollution free replacement for fossil fuels, which is the main reason for global warming and degradation of ecosystem.

There are thousands of successful magnetic energy generators being built around the world, which is a proof that this technology really works. We predict that the technology will rapidly spread, and some industry-insiders even predict that the magnetic energy generator will be the energy of the future. This generator is safe to use and operate. It doesn't produce any harmful byproducts or gases, and there isn't any hazard concerning the generator itself. There are many people that claim the concept of magnetic generator is legit and some people allege that there is a conspiracy keeping the public from getting access to this type of technology.

With a magnetic energy generator, you will be able to generate completely free electricity or energy. This device is safe and eco-friendly.

The Adams Motor - The late Robert Adams, an electrical engineer of New Zealand designed and built several varieties of electric motor using permanent magnets on the rotor and pulsed electromagnets on the frame of the motor (called the "stator" because it does not move). He found that if they were configured correctly, then the output from his motors exceeded their input power by a large margin (800%).



The diagram of his motor intended to show the basic operating principle is shown here:

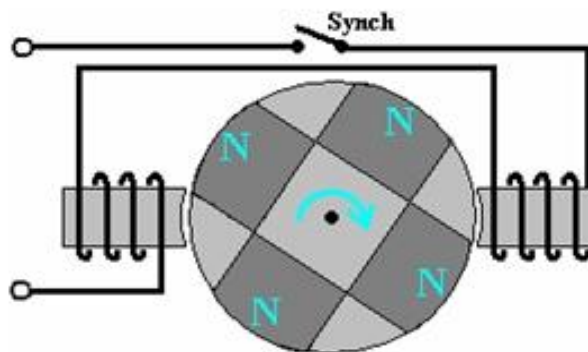

If a motor is built like this, then it will most certainly work and will reach 100% efficiency let alone exceeding the 100% mark. It is only with a specific configuration which is hardly ever publicised that high performance figures can be achieved. While Robert has shown several different configurations, in order to avoid confusion I will describe and explain just one of them.

First and foremost, high performance can only be achieved with the clever use of power collection coils. These coils need to be positioned accurately and their power collection restricted to just a very short arc of operation by connecting them to, and disconnecting them from, the output circuit at just the right instant so that the back EMF generated when the current draw stops, actually contributes to the drive of the rotor, speeding it on it's way and raising the overall efficiency of the motor/generator as a whole.

Next, the shape of the magnets used is important as the length to width proportion of the magnet alters the pattern of it's magnetic fields. In direct opposition to the diagram shown above, the magnets need to be much longer than their width (or in the case of cylindrical magnets, much longer than their diameter).

Further, a good deal of experimentation has shown that the size and shape of the electromagnets and pick-up coils has a major influence on the performance. The cross-sectional area of the core of the pick-up coils

should be four times that of the cross-sectional area of the permanent magnets in the rotor. The reverse is true for the cores of the drive coils as their cores should have a cross-sectional area of just one quarter of the rotor magnet cross-sectional area.

Another point which is almost never mentioned is the fact that big circuit gains will not be achieved unless the drive voltage is high. The minimum should be 48 volts but the higher the voltage, the greater the energy gain, so voltages in the 120 volts (rectified US mains voltage) to 230 volts (rectified mains voltage elsewhere) should be considered. Neodymium magnets are not recommended for drive voltages under 120 volts.

This is one of Robert's test circuits:

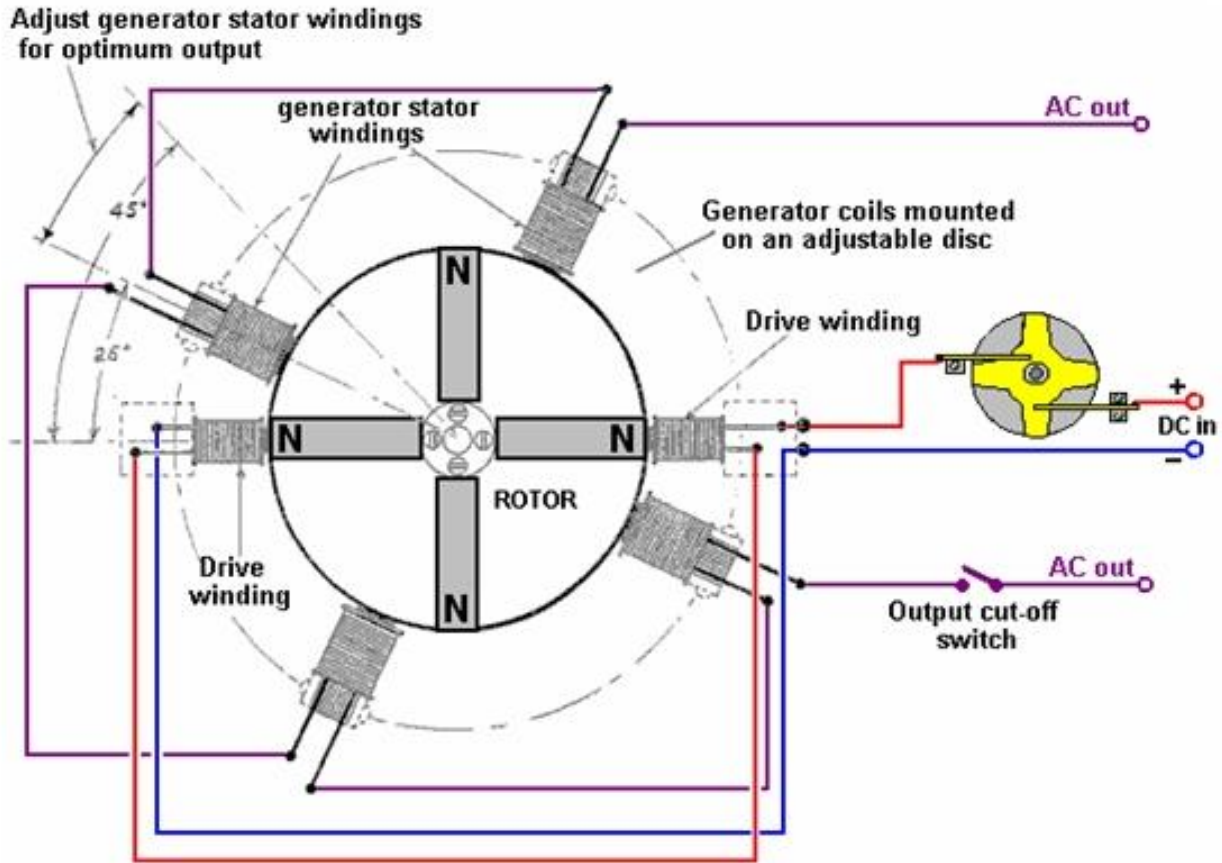

Notice that the cores of the "generator" pick-up coils are very much wider than the cores of the drive coils. Also notice the proportions of the magnets where the length is much greater than the width or diameter. The four generator windings are mounted on a single disc allowing them to be moved through an angle to find the optimum operating position before being locked in position and the two drive coils are mounted separately and held clear of the disc. Notice also that the power pick-up coils are much wider compared to their length than the drive coils are. This is a practical feature which is explained in greater detail later.

The DC input is shown passing through Robert's custom-made contactor switch which is mounted directly on the shaft of the motor/generator. This is a mechanical switch which allows an adjustable On / Off ratio, which is known as the "Mark/Space Ratio" or, if the "On" period is of particular interest, the "Duty Cycle". Robert Adams indicates that when the motor is running and has been adjusted to its optimum performance, then the Mark/Space ratio should be adjusted to minimise the On period and ideally get it down to about 25% so that for three quarters of the time, the input power is actually switched off. There are various ways of achieving this switching while still having a very sharp turn on and turn off of the power.

Robert considered mechanical switching of the drive current to be a very good option although he was not opposed to using the contact to power a transistor to do the actual switching and so reduce the current through the mechanical contacts by a major factor. His reasons for his preference for mechanical switching are that it gives very sharp switching, needs no electrical power to make it operate and it allows current to

flow in both directions. The current flow in two directions is important because Robert produced various ways of getting the motor to feed current back into the driving battery, allowing it to drive the motor for long periods without lowering its voltage hardly at all. His preferred method of switching is shown here:

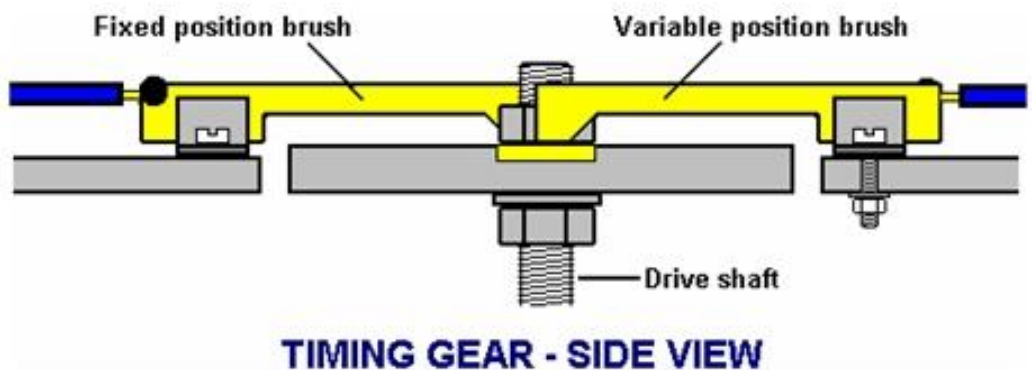
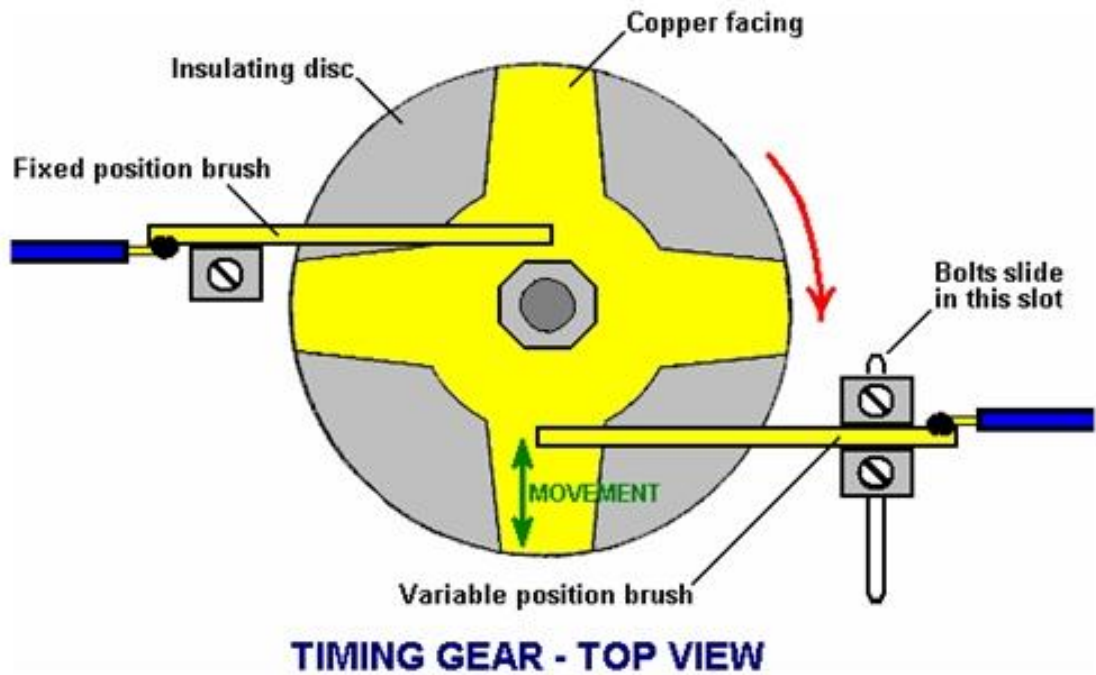

This switching gear operates as follows: The timing disk is bolted securely to the drive shaft of the motor and its position is set so that the electrical switch-on occurs when the rotor magnet is exactly aligned with the drive coil core. Adjustment of that timing is done by loosening the locking nut, rotating the disc very slightly and clamping the disc in position again. A spring washer is used to keep the assembly tight when the device is running. The disc has a star-shaped piece of copper sheet set into its surface and two silver-tipped, copper arm "brushes" slide across the surface of the copper star.

One of these two brushes is fixed in position and slides across the copper star near the drive shaft, making a permanent electrical connection to it. The second brush slides alternatively on the non-conducting surface of the disc and then over the conducting arm of the copper. The second brush is mounted so that its position can be adjusted and, because the copper arms taper, that alters the ratio of the "On" time to the "Off" time. The actual switching is achieved by current flowing through the first brush, through the copper arm and then through the second brush. The brush arms shown in the diagram above rely on the springiness of the copper arm to make a good brush-to-copper electrical connection. It might be preferred to use a rigid brush arm, pivot it and use a spring to ensure a very good contact between the brush and the copper star at all times.

The adjustment of the On to Off time, or "Mark/Space Ratio" or "Duty Cycle" as the technical people describe it, could perhaps do with some description. If the moveable brush is positioned near the centre of the disc, then, because of the tapering of the copper arms, the part of the non-conducting disc that it slides over is shorter and the part of the conducting copper arm with which it connects is longer, as the two sliding paths are about the same length, the current is on for about the same length as it is off, giving a Mark/Space ratio of about 50% as shown here:

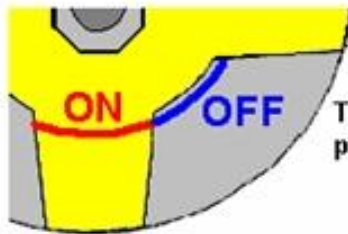

The On path is about the same length as the Off path and so the Mark/Space ratio is about 50%

If, instead, the moveable brush is positioned near the outside edge of the disc, then because of the tapering of the copper arm, the On path is shorter and the non-conducting Off path is very much longer, being about three times as long as the On path, giving a Mark/Space ratio of about 25%. As the moveable brush can be positioned anywhere between these two extremes, the Mark/Space ratio can be set to any value from 25% to 50%.

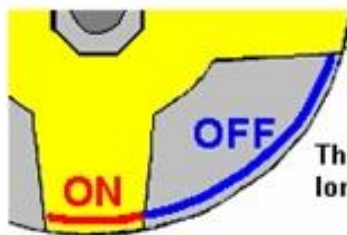

The On path is shorter and the Off path is much longer giving a Mark/Space ratio of about 25%

The two brushes can be on the same side of the drive shaft or on opposite sides as shown. One important feature is that the brushes touch in a position where the disc surface is always moving directly away from the brush mounting, causing any drag to be directly along the arm and giving no sideways loading on the brush. The diameter of the device is usually one inch (25 mm) or less.

You will also notice that the output is switched although the diagram does not give any indication of how or when that switching takes place. You will notice that the diagram has angles marked on it for the optimum positioning of the pick-up coils, well, an Adams Motor builder with a forum ID of "Maimariati" who achieved a Coefficient Of Performance of 1,223, found that the optimum switching for his motor is On at 42 degrees and Off at 44.7 degrees. That tiny 2.7 degree part of the rotor turn gives a substantial power output and cutting the output current off at that point causes the back EMF of the coils to give the rotor a substantial additional boost on its way. His input power is 27.6 watts and the output power is 33.78 kilowatts

Now for some practical details: It is suggested that a good length for the power pick-up coils can be determined by using the "paper clip test". This is done by taking one of the permanent magnets used in the rotor, and measuring the distance at which that magnet just begins to lift one end of a 32 mm (1.25 inch) paper clip off the table. The optimum length of each coil from end to end is exactly the same as the distance at which the paper clip starts to lift.

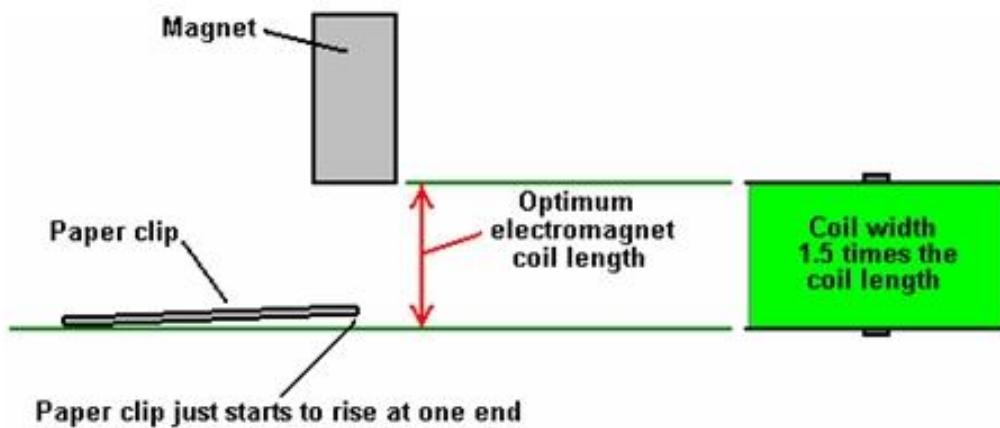

The core material used in the electromagnets can be of various different types including advanced materials and alloys such as 'Somalloy' or 'Metglas'. The power pick-up coil proportions are important as an electromagnet becomes less and less effective as its length increases, and eventually, the part furthest from the active end can actually be a hindrance to the effective operation. A good coil shape is one which you would not expect, with the coil width being, perhaps 50% greater than the coil length:

Contrary to what you would expect, the device draws in energy from the local environment better if the end of the pick-up coil farthest from the rotor is left unaffected by any other part of the device and the same applies to the magnet facing it. That is, the coil should have the rotor at one end and nothing at the other end, that is, no second rotor behind the coil. The speed at which the voltage is applied to, and removed from, the coils is very important. With very sharp voltage rises and falls, additional energy is drawn from the surrounding environmental energy field. If using transistor switching, then the IRF3205 FET has been found to be very good and a suitable driver for the FET is the MC34151.

If using a Hall-effect semiconductor to synchronise the timing, say the UGN3503U which is very reliable, then the life of the Hall-effect device is much improved if it is provided with a 470 ohm resistor between it and the positive supply line, and a similar 470 ohm resistor between it and the negative line. These resistors in series with the Hall-effect device effectively "float" it and protect it from supply-line spikes".

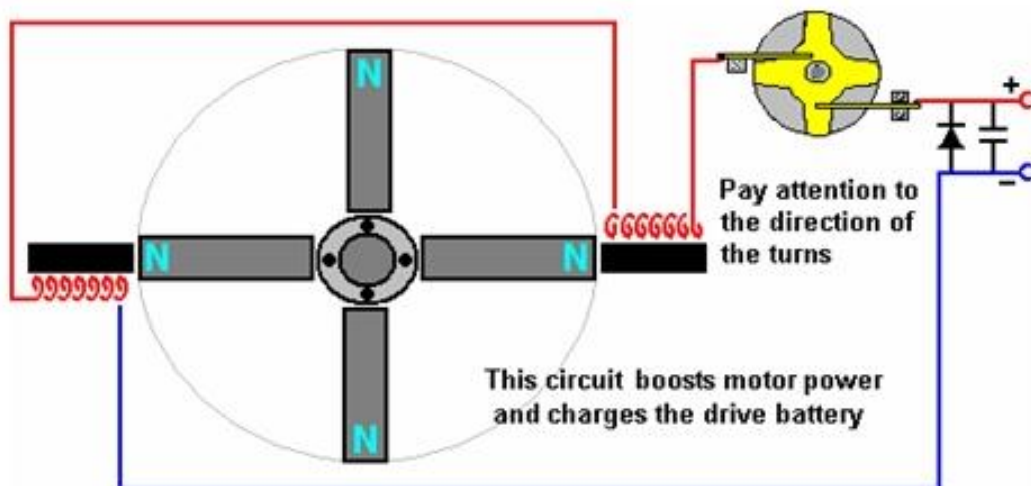

Here, two electromagnets are driven by the battery via Robert's 4-arm commutator which is mounted on the rotor shaft. Some of the recommendations given by Robert are the opposite of what you would expect. For example, he says that a single rotor construction tends to be more electrically efficient than one where several rotors are mounted on a single shaft. Robert is against the use of reed switches and he recommends making one of his commutators.

At one stage, Robert recommended the use of standard transformer shims for constructing the cores of the electromagnets. This has the advantage that matching bobbins for holding the coil windings are readily available and can still be used for pick-up coils. Later on, Robert swung towards the use of solid cores from the old PO Series 3000 telephone relays and eventually said that electromagnet cores should be solid iron.

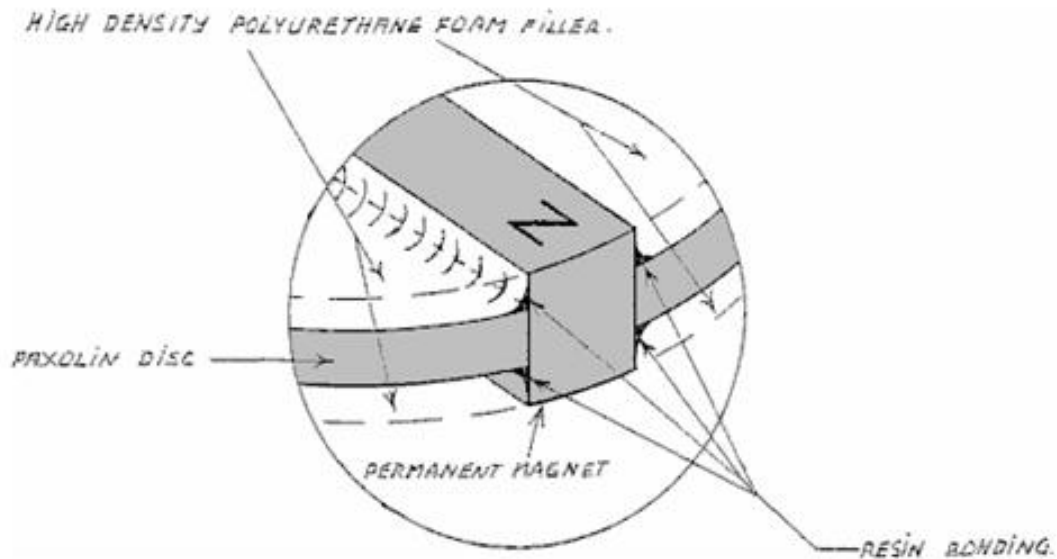

The diagrams presented by Robert show the magnets located on the rim of the rotor and pointing outwards. If this is done, then it is essential that the magnets in the rotor are firmly attached on at least five of their six faces and the possibility of using a ring of non magnetic material such as duct tape around the outside should be considered. That style of construction also lends itself to streamlining the rotor by having a completely solid construction, although it might be remarked that the motor would run better and more quietly if it were enclosed in a box which had the air pumped out of it. If that is done, then there will be no air resistance and because sound can't pass through a vacuum, quieter operation is bound to result.

While this may sound a bit complicated, there is no reason why it should be. All that is needed is two discs and one central disc which is the thickness of the magnets, with slots cut in it, the exact size of the magnets. The assembly starts with the lower disc, magnets and central disc. These are glued together, probably with epoxy resin, and that holds the magnets securely on four faces as shown here:

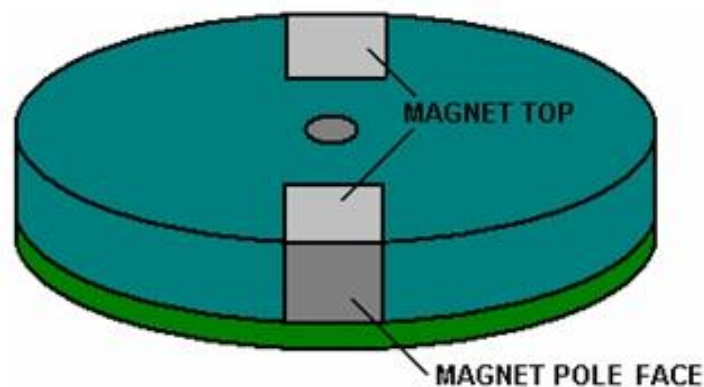

Here, the magnets are attached on the lower face, the right and left faces, and the unused pole face, and when the upper disc is attached, the upper faces are also secured and there is the minimum of air turbulence when the rotor spins:

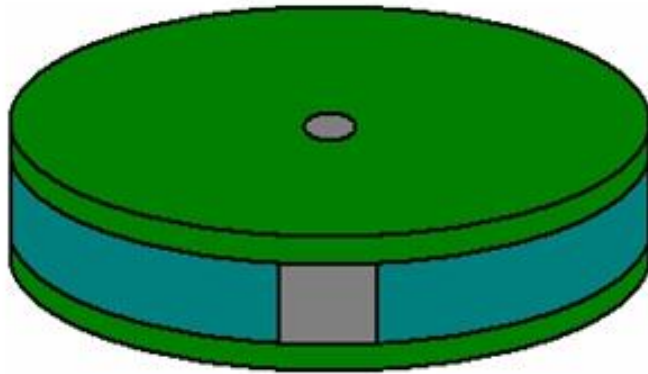

There is a "sweet spot" for the positioning of the power pick-up coils and it will usually be found that this is two or three millimeters away from the rotor. If that is the case, then there will be room for an outer band of duct tape on the rim of the rotor to provide additional protection against the failure of the magnet attachment method.

High-power versions of the motor/generator need to be enclosed in a metal box which is earthed as they are quite capable of generating a substantial amount of high frequency waves which can damage equipment such as oscilloscopes and create TV reception interference. There would probably be an improvement in performance as well as a reduction in sound if the box was airtight and had the air pumped out of it. If that is done, then there will be no air resistance as the rotor spins and since sound does not pass through a vacuum, quieter operation is possible.

Experienced rotor builders do not like the radial magnets style of construction because of the stresses on the magnet attachments if high rotational speeds are reached. It should not need to be said, but it is obviously a major requirement to keep your hands well away from the rotor when the motor is running as it is perfectly possible to be injured by the high-speed movement if you are careless. Please remember that this presentation must not be considered to be a recommendation that you build or use any device of this nature and it must be stressed that this text, in common with the entire contents of this eBook, is intended to be for information purposes only and no representations or warranties are implied by this presentation. Should you decide to construct, test or use any device, then you do so entirely at your own risk and no liability attaches to anybody else if you sustain any kind of injury or property damage as a result of your own actions.

Because of the mechanical stresses caused during rotation, some experienced constructors feel that the magnets should be embedded in the rotor as shown here where they are kept well clear of the rim of a rotor which is made from a tough material. This is so that the outer strip of the material prevents the magnets breaking loose and becoming dangerous high-speed projectiles, which at best would destroy the electromagnets and at worst could injure someone quite badly:

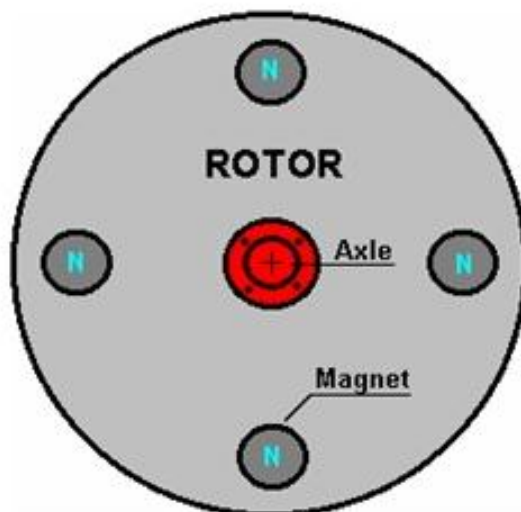

It needs to be remembered that the proportions of the magnets are for the magnet length to be more than the diameter, so in cases like this where circular magnet faces are to be used, the magnets will be cylindrical and the rotor needs to have a significant thickness, which will depend on the magnets which are available locally. The magnets should be a tight push-fit in their holes and securely glued in place.

Robert Adams has used this construction style as well. However, if an arrangement like this is used, then there will be a substantial sideways pull on the rotor as it reaches the electromagnet core, tending to pull the magnets out of the rotor.

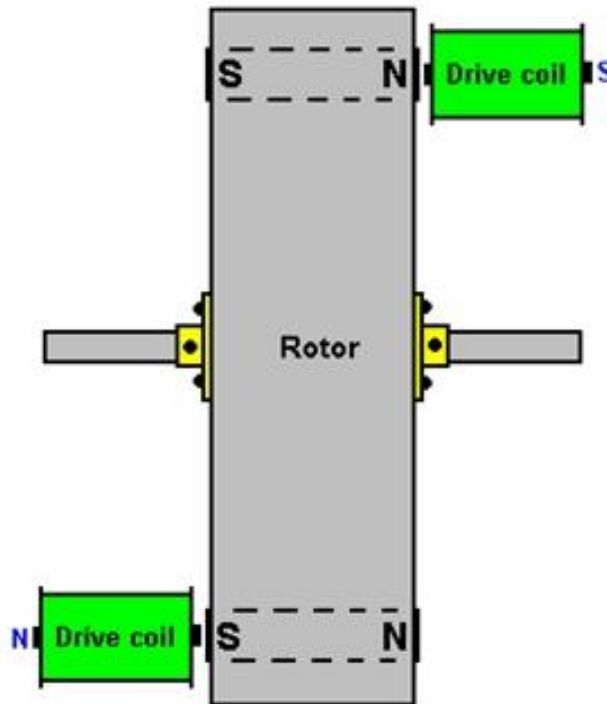

It is important that the rotor should be perfectly balanced and have the minimum amount of bearing friction possible. This calls for precision construction and either roller or ball bearings. The construction style shown above has the distinct advantage that it has an open end to both the magnet and the coils and this is believed to facilitate the inflow of environmental energy into the device.

It may be my ignorance showing here, but I have a problem with this version. The difficulty as I see it is that the magnet/core pull and the subsequent drive thrust when the coil is powered, form a "turning couple" as they both try to rotate the axle in the same direction. This places a substantial loading on the axle bearings, usually amplified by the radius of the rotor being greater than the distance from the rotor to the axle bearings. This load will be in the tens of kilograms range and will be applied and reversed perhaps forty times per second. To me, that appears like a vibration load and is directly opposed to the "perfectly balanced" rotor operation being sought. The radial magnet arrangement generally shown by Robert Adams does not have any of this kind of loading at all because the coils are exactly opposite each other and their loads cancel each other out exactly. The choice is, of course, up to the builder and his assessment of the advantages and disadvantages of the different styles of construction.

When getting ball-race bearings for an application like this, please be aware that "closed" bearings such as these are not suitable as supplied:



This is because this type of bearing is usually packed with dense grease which completely destroys its free motion, making it worse as a bearing than a simple hole-and-shaft arrangement. However, in spite of this, the closed or "sealed" bearing is popular as the magnets tend to attract dirt and dust and if the device is not enclosed in a steel box as is necessary for the high power versions, then having the seal is considered to be an advantage. The way to deal with the grease packing is to soak the bearing in an isopropyl solvent cleaner to remove the manufacturer's grease, and then, when it has dried out, lubricate the bearing with two drops of a high quality thin oil. If it is intended to house the motor/generator in an earthed, sealed steel box then an alternative type of bearing which might be suitable is an open design like this:



especially if the air is removed from the box. Some constructors prefer to use ceramic bearings which are supposed to be immune to dirt. One supplier is <http://www.bocabearings.com/main1.aspx?p=docs&id=16> but as with everything else, these choices have to be made by the builder and will be influenced by his opinions.

I'm not sure where it came from, but here is a circuit diagram showing a transistor drive and the return of the back EMF of the drive coils to the driving power supply. Using this method, about 95% of the drive current can be returned, lowering the current draw enormously:

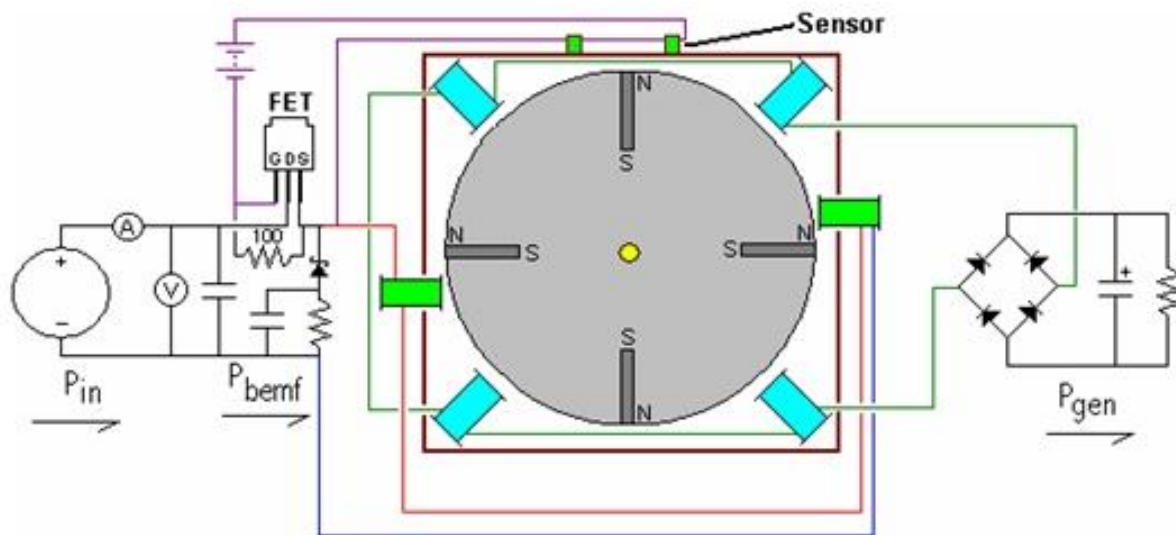

The diode feeding the power back to the supply is a Schottky type because of its high-speed operation. It needs to be able to handle the peak pulse power and so should be one of the more robust types. What this circuit does not have is the very important switching on the output coils circuit. Another strange item is the way that the FET sensor is arranged with two sensors rather than one and with an additional battery. While it must be admitted that the current draw of the FET gate should be very low, there still does not seem to be much reason to have a second power supply. One other peculiarity in this diagram is the positioning of the drive coils. With them offset as shown, it has the effect of them being at an angle relative to the rotor magnets. It is not at all clear if this is an advanced operating technique or just poor drawing - I am inclined to assume the latter although I have no evidence for this other than the circuit design and the low quality of the original drawing which had to be improved considerably to arrive at the diagram shown above.

The coil generator output should be fed into a capacitor before being passed to whatever equipment is to be powered by the device. This is because the energy is being drawn from the local environment and is not conventional energy. Storing it in a capacitor converts it to a more normal version of electrical power, a feature which has also been mentioned by Don Smith and by John Bedini although their devices are quite different in operation.

The DC resistance of the coil windings is an important factor. The overall resistance should be either 36 ohms or 72 ohms for a complete set of coils, whether they are drive coils or power pick-up coils. Coils can be wired in parallel or in series or in series/parallel. So, for 72 ohms with four coils, the DC resistance of each coil could be 18 ohms for series-connected, 288 ohms for parallel connected, or 72 ohms for connection in series/parallel where two pairs of coils in series are then wired in parallel.

To help with assessing the wire diameter and length which you could use, here is a table of some of the common sizes in both American Wire Gage and Standard Wire Gauge:

AWG	Dia mm	SWG	Dia mm	Max Amps	Ohms / 100 m
11	2.30	13	2.34	12	0.53
12	2.05	14	2.03	9.3	0.67
13	1.83	15	1.83	7.4	0.85
14	1.63	16	1.63	5.9	1.07
15	1.45	17	1.42	4.7	1.35
16	1.29	18	1.219	3.7	1.70
18	1.024	19	1.016	2.3	2.7
19	0.912	20	0.914	1.8	3.4
20	0.812	21	0.813	1.5	4.3
21	0.723	22	0.711	1.2	5.4
22	0.644	23	0.610	0.92	6.9
23	0.573	24	0.559	0.729	8.6
24	0.511	25	0.508	0.577	10.9
25	0.455	26	0.457	0.457	13.7
26	0.405	27	0.417	0.361	17.4
27	0.361	28	0.376	0.288	21.8
28	0.321	30	0.315	0.226	27.6
29	0.286	32	0.274	0.182	34.4
30	0.255	33	0.254	0.142	43.9
31	0.226	34	0.234	0.113	55.4
32	0.203	36	0.193	0.091	68.5
33	0.180	37	0.173	0.072	87.0
34	0.160	38	0.152	0.056	110.5
35	0.142	39	0.132	0.044	139.8

So far, we have not discussed the generation of the timing pulses. A popular choice for a timing system is to use a slotted disc mounted on the rotor axle and sensing the slots with an "optical" switch. The "optical" part of the switch is usually performed by UV transmission and reception and as ultra violet is not visible to the human eye, describing the switching mechanism as "optical" is not really correct. The actual sensing mechanism is very simple as commercial devices are readily available for performing the task. The sensor housing contains both a UV LED to create the transmission beam, and a UV dependent resistor to detect that transmitted beam.

Here is an example of a neatly constructed timing mechanism made by Ron Pugh for his six-magnet rotor assembly:

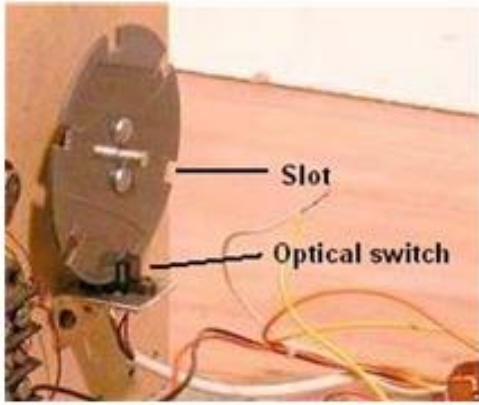

and the switch/sensor:





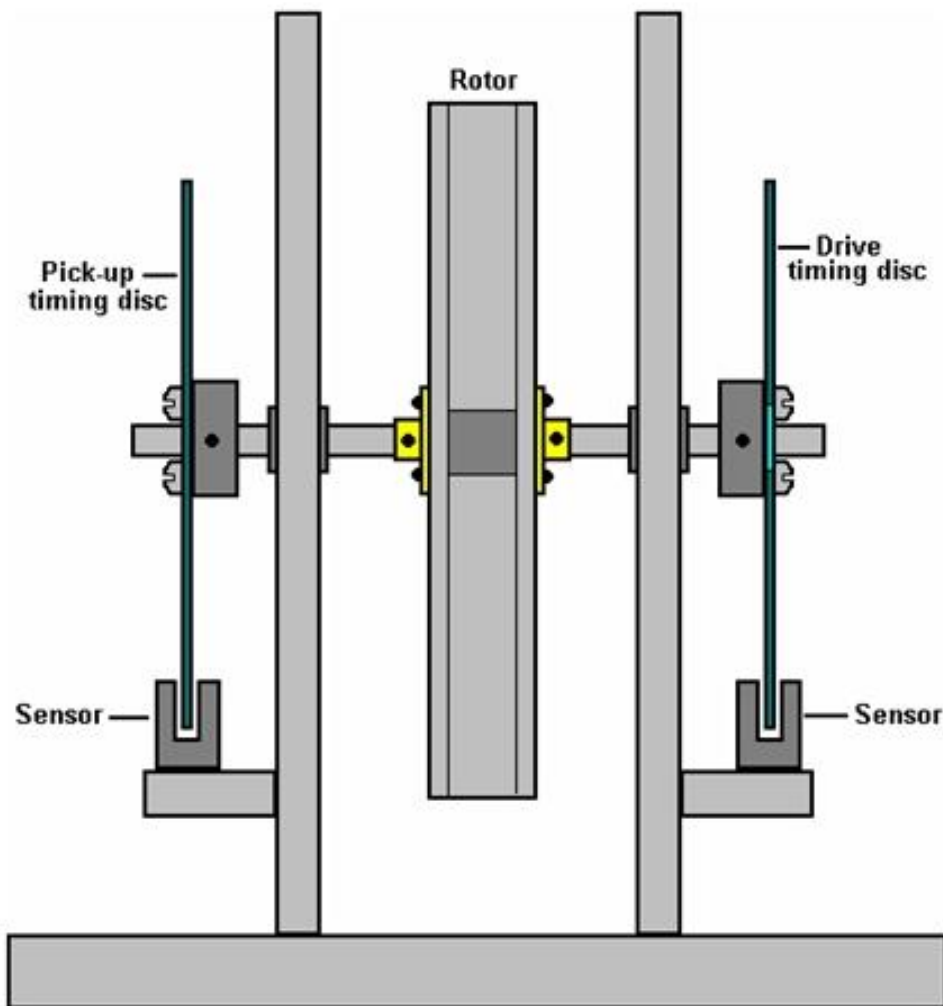

This device happens to be one which is supplied by www.bayareaamusements.com under their product code number : OP-5490-14327-00. As the slotted disc rotates, one of the slots comes opposite the sensor and allows the UV beam to pass through to the sensor. That lowers the resistance of the sensor device and that change is then used to trigger the drive pulse for whatever length of time the slot leaves the sensor clear. You will notice the balanced attachment method used by Ron to avoid having an unbalanced rotor assembly. There can be two timing discs, one for the drive pulses and one for switching the power pickup coils in and out of the circuit. The slots in the power pick-up timing disk will be very narrow as the switch-on period is only about 2.7 degrees. For a six-inch diameter disc where 360 degrees represents a circumference length of 18.85 inches (478.78 mm) a 2.7 degree slot would be only 9/64 inch (3.6 mm) wide. The arrangement for an axial magnet rotor set-up could be like this:



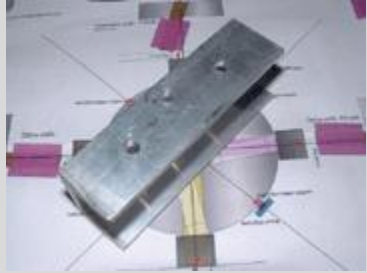

So to recap, the things which are necessary for getting an Adams Motor output into the serious bracket are:

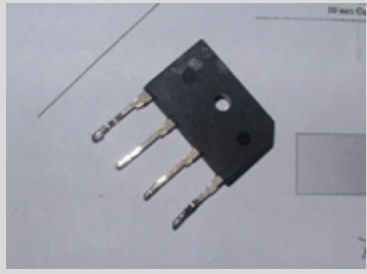

1. A performance of $COP > 1$ can only be achieved if there are power pick-up coils.
2. The rotor magnets need to be longer than they are wide in order to ensure the correct magnetic field shape and the rotor must be perfectly balanced and have bearings as low-friction as possible.
3. The face area of the rotor magnets needs to be four times that of the drive coil cores and one quarter the area of the core of the power pick-up coils. This means that if they are circular, then the drive coil core diameter needs to be half the diameter of the magnet and the magnet diameter needs to be half the diameter of the power pick-up core. For example, if a circular rotor magnet is 10 mm across, then the drive core should be 5 mm across and the pick-up core 20 mm across.
4. The drive voltage needs to be a minimum of 48 volts and preferably, a good deal higher than that.
5. Do not use neodymium magnets if the drive voltage is less than 120 volts.
6. The drive coils should not be pulsed until they are exactly aligned with the rotor magnets even though this does not give the fastest rotor speed.
7. Each complete set of coils should have a DC resistance of either 36 ohms or 72 ohms and definitely 72 ohms if the drive voltage is 120 volts or higher.
8. Collect the output power in large capacitors before using it to power equipment. It may also be possible to boost the output power further, by using the Coil-Shorting technique shown in the section of this chapter on the RotoVerter.

Parts list

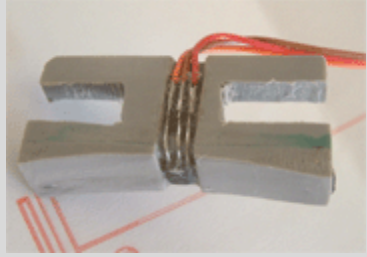
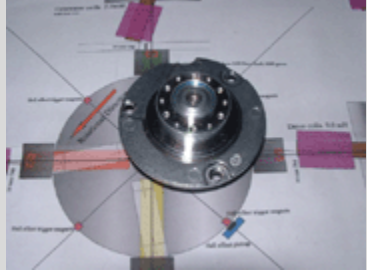
Part Number	Part Description	Amount	Cost Per Unit	Total Cost	Map No.	
	Aluminum channel Core support Bracket	4				
	500 mm x 15mm PVC base board	1				
	500 mm x 15mm PVC base board	1				
XRL 50V4 700	Radial Electrolytic Capacitor 50V 4700mF 20%	1				

	connector	1				
	30 x 25.4mm N45 Rare Earth 6000 gauss	4				
	5mm x 5mm trigger magnets	4				

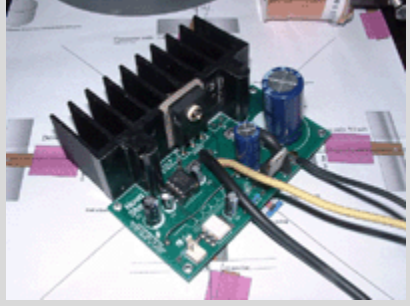
	Hall Device Mounted	1				
	Old hard Drive bearing you can Source your own or email for possible availability	1				
	Generator pick up coils large inductors On iron core 5.6 m Henries .5 ohm	2				
	Generator pick up coils large inductors On iron core 9.0 m Henries .9 ohm	2				

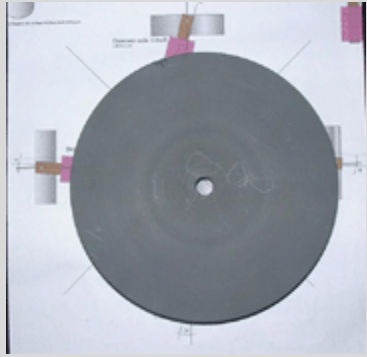
	<p>Nova Star Driver circuit 20 amps rated</p>	<p>1</p>				
	<p>Processor controller Comes programmed specially for this application. Used to control the drive duration and pulse rapid firing to generate High voltage back emf. All controlled by two small tactile buttons and information feed back to the lcd display. Connects to the Amplifier output model.</p>	<p>1</p>				
	<p>PVC disk 150mm x 10 mm</p>	<p>1</p>				

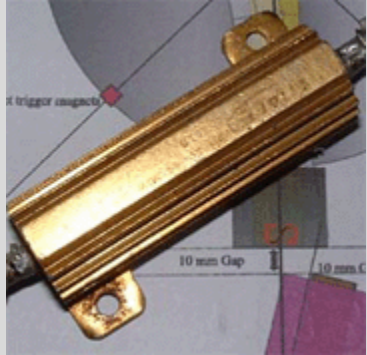
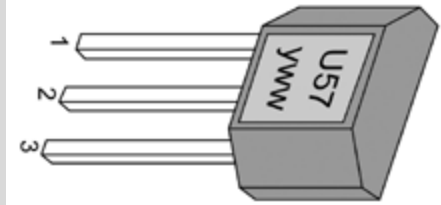
	Shut load resistor 1.5 ohm 10 Watt	1				
	US5781 Unipolar Hall Switch – Medium Sensitivity	1				
	Miscellaneous Wire and clips Small connectors					